

Drawer construction and installation

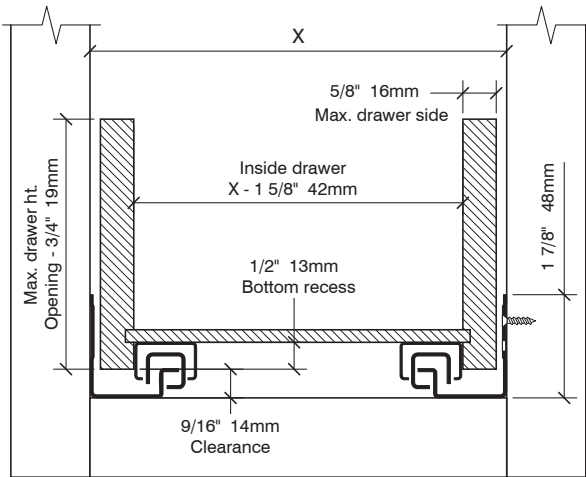

1 Calculate drawer size from cabinet opening



Important:

Inside drawer dimension needs to be accurate to fit over drawer slides.
 Drawer length limited to: 21" 533mm, 18" 457mm, 15" 381mm & 12" 305mm.

3 Bore rear hook holes

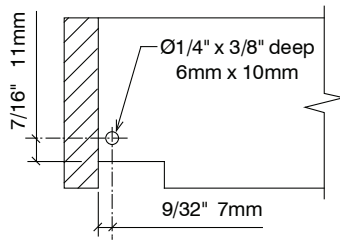

4 Install locking devices

Attach to drawer front with #6 x 1/2" pan head screws

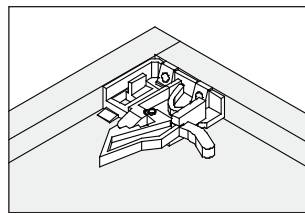

5 Install rear sockets - Face frame cabinets only

1. Project the inside corner of the face frame on to the cabinet back
2. Mark the centers for the screws
3. Attach with #6 FH screws

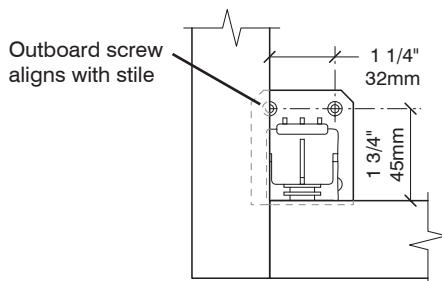

2 Build the drawer

Two construction techniques

Standard

Four sided box with decorative front attached to the front of the drawer

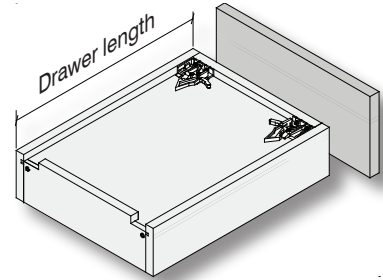

Interior roll-out drawer

Four sided box with integral drawer front
IMPORTANT: Overall drawer length: 21", 18", etc. includes drawer front

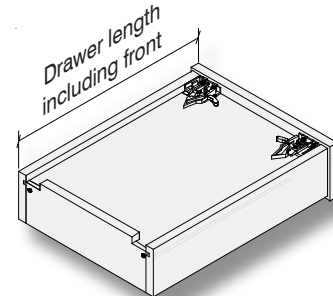

Notch drawer back for slide clearance

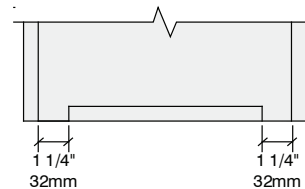

6 Mount slides to cabinet

1. Insert slide into rear socket (face frame only)
2. Position slide 5/32" back from the cabinet face
3. Attach with #7 FH screws or Euro screws in pre-bored Ø5mm holes

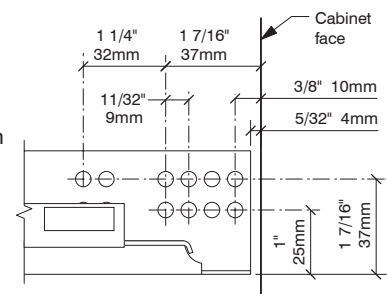

ID: FCDS-V3-081909